

**I
P
U**

**APR
SALE**

**TRANSPORTATION PARTS UNLIMITED
7800 WEST 60TH PL. SUMMIT, IL 60501
708-594-1515 TPU-USA.COM**

**APR
SALE**

**I
P
U**

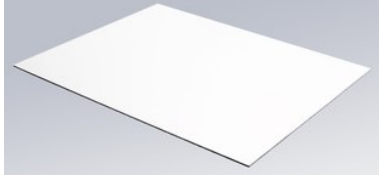

**49X110 (.050) FLAT SIDE PANELS
PP/WHITE**

\$65.00 EA

25 OR MORE \$62.50 EA

TPU PART # 03TP01

**VARIOUS SALE ITEMS
DO NOT QUALIFY FOR
PRE-PAID FREIGHT**

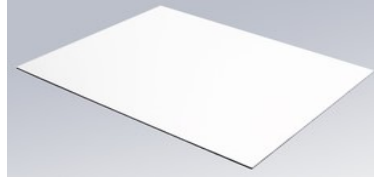

**49X110 (.040) FLAT SIDE PANELS
PP/WHITE**

\$46.00 EA

TPU PART # 03TP1

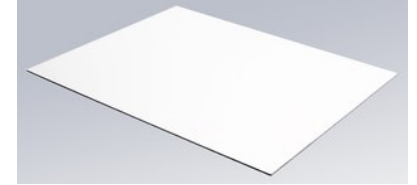

**49X105 (.050) FLAT SIDE PANELS
PP/WHITE**

\$45.00 EA

TPU PART # 03TP-10



**REPLACES
STOUGHTON N/S Z-PLATE
ROOF BOWS**

\$10.00 EA

TPU PART #21SN5

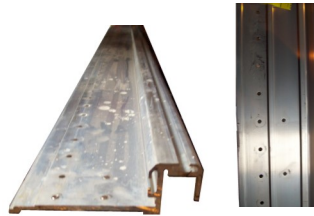

**STOUGHTON 2018 PLT TRL N/ RAIL
02-028844-090-19**

\$75.00 EA

TPU PART # 06SN5

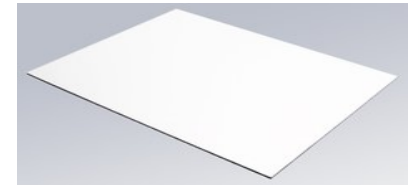

**STOUGHTON Z PLATE PANEL
01-22503XX6**

\$175.00 EA

TPU PART # 03PNLSN

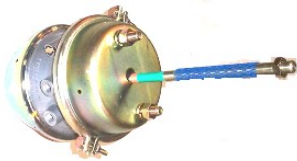

**TYPE 30-30 BRAKE CHAMBER
(LONG STROKE)**

\$38.00 EA

TPU PART # 43BC3

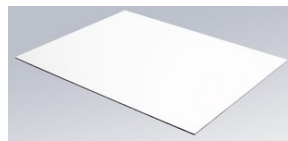

**49X120 (.050) FLAT SIDE PANELS
PP/WHITE**

\$75.00 EA

TPU PART # 03TP2



**3/8 ALUMINUM ROOF EDGE
J-MOLDING 10'**

\$3.95 EA

TPU PART # 21J2

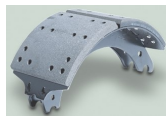

**BRAKE SHOE W/LINING
4515-Q (20K)**

\$12.25 EA

24 OR MORE \$11.75 EA

TPU PART # 25BS11R



D.O.T ICC BUMPER TUBE NO/HOLES

\$85.00 EA

TPU PART # 38CB1-HOL



19 OZ CAN UNDERCOATING

\$5.95 EA

12 OR MORE \$5.50 EA

TPU PART # 52CUNDERCOAT